

OUTDOOR ELEVATOR



Quote

Order





Contact Name: _____ Job Name: _____





Contact Email: _____ Req. Ship Date: _____





Initial Drawing Requested

Drawing Email: _____

Approved for production as listed below.

BASICS	OPENINGS	ENCLOSURES	LANDINGS					
	 Single Opening  Pass Through	 Top Only  Top w/ Plexi Side Enclosure None	2 3 Middle Door LH  RH Customer Provided					
	Pass Through Only	SAFETY PAN						
	<table border="1" style="width: 100%;"> <tr> <th style="width: 50%;">Auto Ramp</th> <th style="width: 50%;">Car Gate</th> </tr> <tr> <td style="text-align: center;">Yes</td> <td style="text-align: center;">RH</td> </tr> <tr> <td style="text-align: center;">No</td> <td style="text-align: center;">LH</td> </tr> </table>	Auto Ramp	Car Gate	Yes	RH	No	LH	Yes No, Hoistway is enclosed
Auto Ramp	Car Gate							
Yes	RH							
No	LH							

TOWER	TOWER HEIGHT	CONFIGURATION	TOWER SUPPORT	TOWER SPLICE	TOWER FASCIA	
	18' (standard) 14' (if code requires) 18' - 25'	<i>As viewed from top landing</i>	Tower on Left Tower on Right	Standoff  Triangle 	No Yes	Solid Panel  Expanded Panel 

DOORS	LOWER DOOR (42" WIDE)	UPPER GATE	
	HEIGHT 85" - 109" 109" - 133" 133" - 157" 157" - 181" Unsure		36" (height) Upper Gate RH LH 42" (height) Upper Gate RH LH
			Solid  Picket 
			Swing  LH RH

POWER	SUPPLY VOLTAGE	WIRE LENGTHS		FINISH	FINISH	
	110 VAC (Non GFI Outlet)		Standard		Custom	Mill Finish
	Battery Lowering	Door/Gate Wire	20'		_____	Powder Coat Matte White
		Travel Cable	20'		_____	Powder Coat Matte Grey

SHIPPING	SHIPPING	ADDITIONAL INFORMATION	
	Pick Up		
	Delivery (if available)		
	Shipping By Others		

PLEASE FILL IN THE **TRAVEL DISTANCE** & **HEIGHT TO LOWEST EAVE** VALUES BELOW

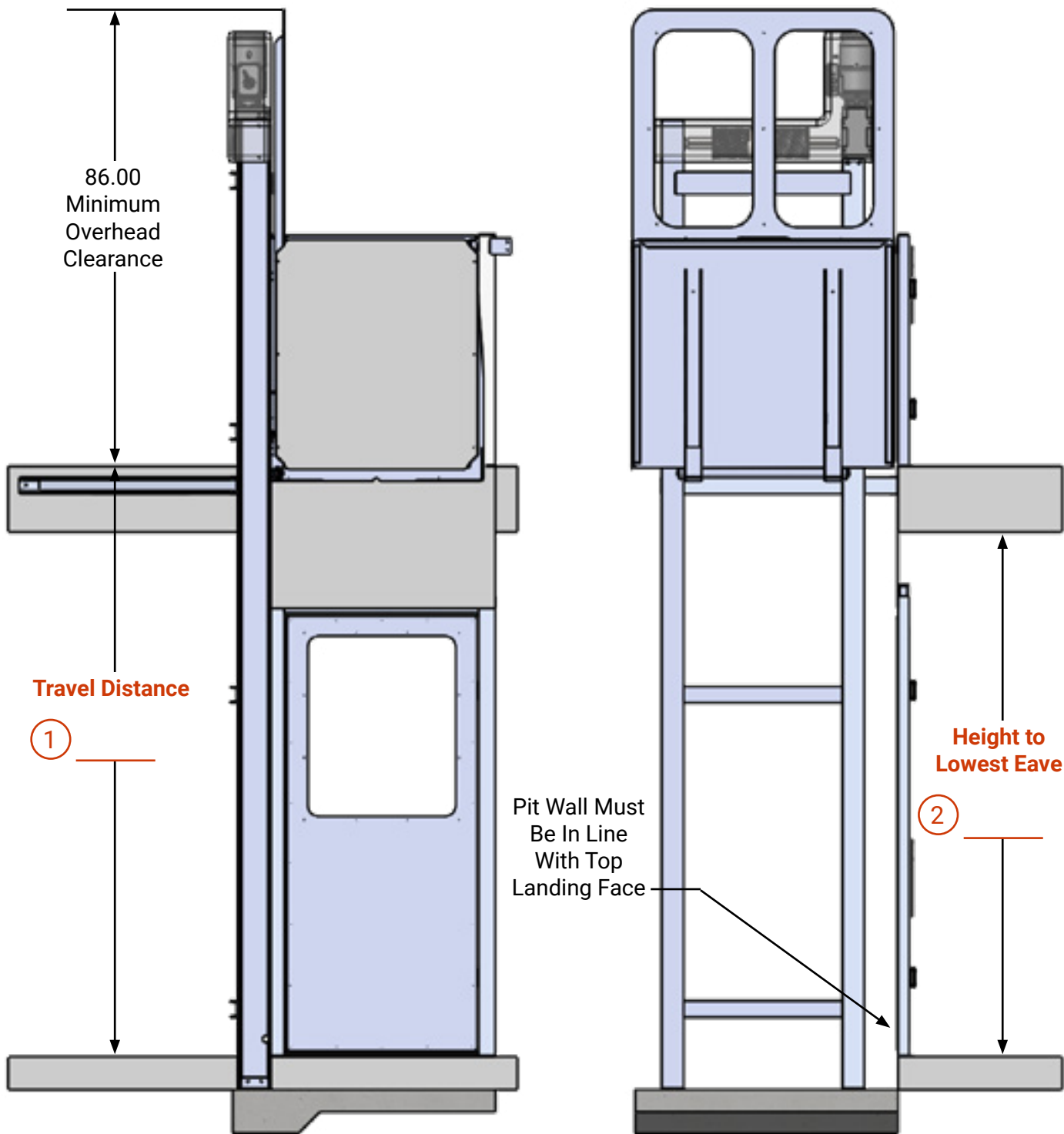

PIT OPTIONS

Recessed 6" Pit

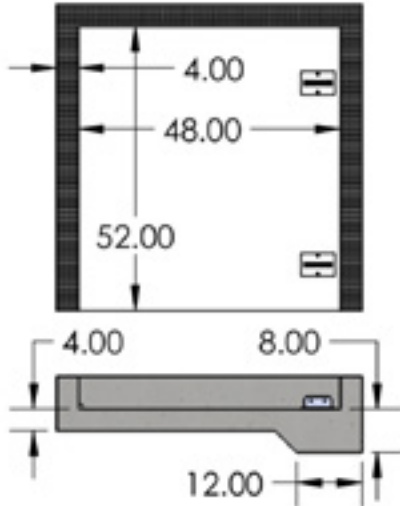

Recessed 6" Slab

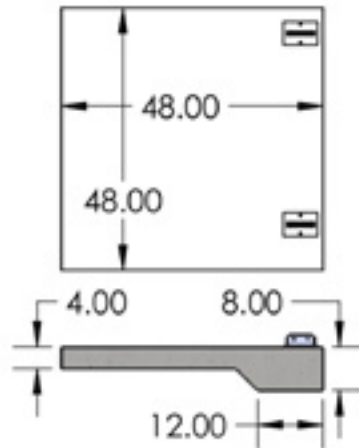

Recessed 6" Footer

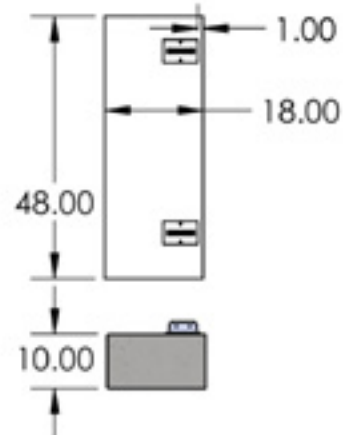

No Pit / 6" Fixed Ramp

No Pit / 6" Fixed Ramp by Others

Gate Opening from Pit Edge	A
LH Swing	4.25
RH Swing	6.25

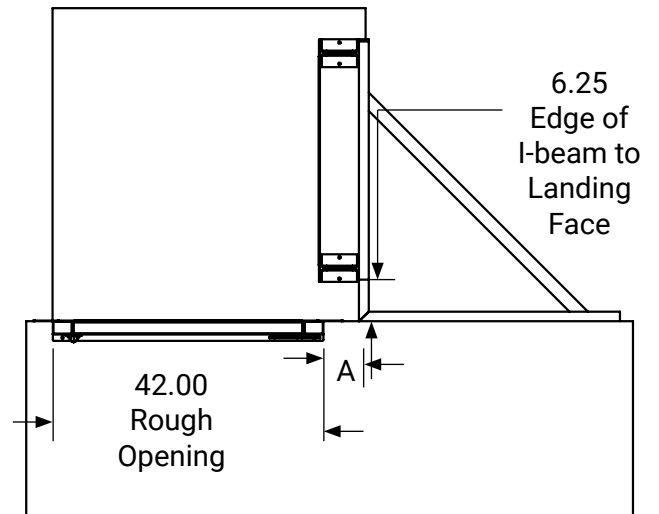

PIT REQUIREMENTS

- » All concrete to be reinforced with #3 rebar @ slab/footer mid-depth.
- » 6" depression recommended from bottom floor to pit/slab/footer.
- » Dimensions must meet or exceed minimum requirements listed above.

ELECTRICAL REQUIREMENTS

CONTROLLER COMES EQUIPPED WITH A 120VAC PLUG/PIGTAIL.
 REQUIRES A DEDICATED CIRCUIT, 120VAC, 20AMP OUTLET WITHIN SIGHT OF THE LIFT.
 FOR JURISDICTIONS WHICH REQUIRE THE CONTROLLER TO BE HARDWIRED,
 CUT CORD END AND HARD WIRE INTO APPROPRIATE DISCONNECTING MEANS.
 CORD MAY ALSO BE REMOVED AND REPLACED WITH APPROPRIATE WIRE SUPPLIED BY OTHERS.